

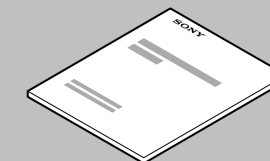

Gids voor snelle instelling/Guida di configurazione rapida

DAV-DZ730



Meer informatie vindt u in de gebruiksaanwijzing.
Per ulteriori dettagli, consultare le Istruzioni per l'uso.

1 De luidsprekers aansluiten/Collegamento dei diffusori

Monteer eerst de luidsprekers (raadpleeg hiervoor de Installatiegids voor de luidspreker) en sluit vervolgens de luidsprekerkabels aan op de SPEAKERS-aansluitingen van het toestel met dezelfde kleur.

Anzitutto montare i diffusori (fare riferimento alla Guida all'installazione dei diffusori), quindi collegare i cavi dei diffusori rispettando le impostazioni dei colori delle prese SPEAKERS dell'unità.

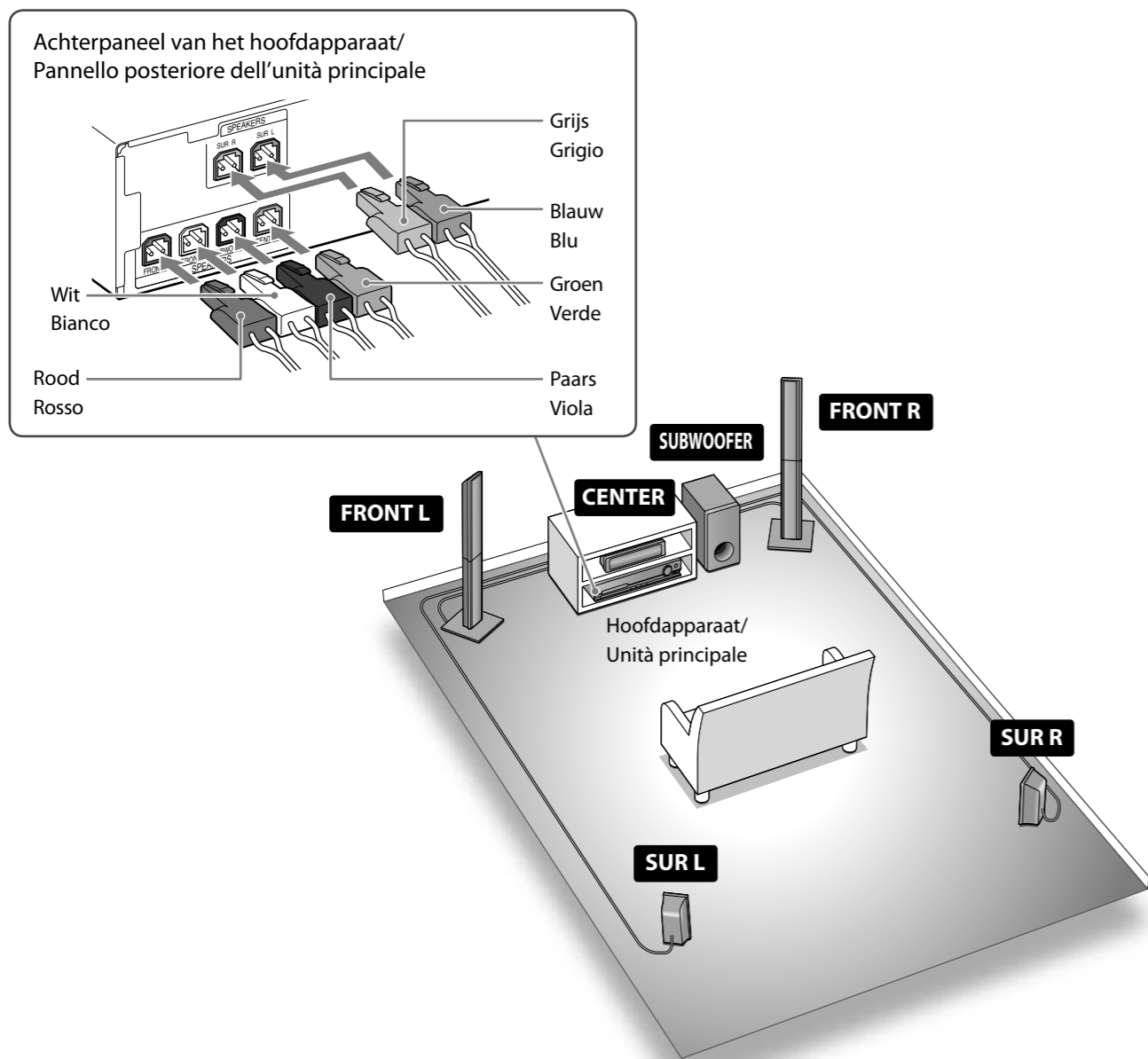

De luidsprekerkabels aansluiten op de luidspreker/
Per collegare i cavi del diffusore al diffusore

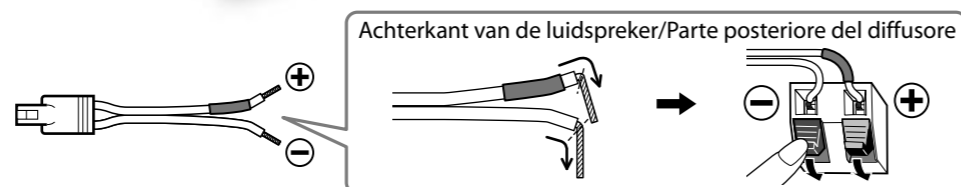

2 Een tv/set-top box aansluiten/Collegamento del televisore/decoder

Selecteer de aansluitingswijze voor video en audio afhankelijk van de aansluitingen op uw tv of set-top box.
In base alle prese sul televisore o sul decoder, selezionare il metodo di collegamento audio e video.

Videoverbinding met de tv/Collegamento del video al televisore

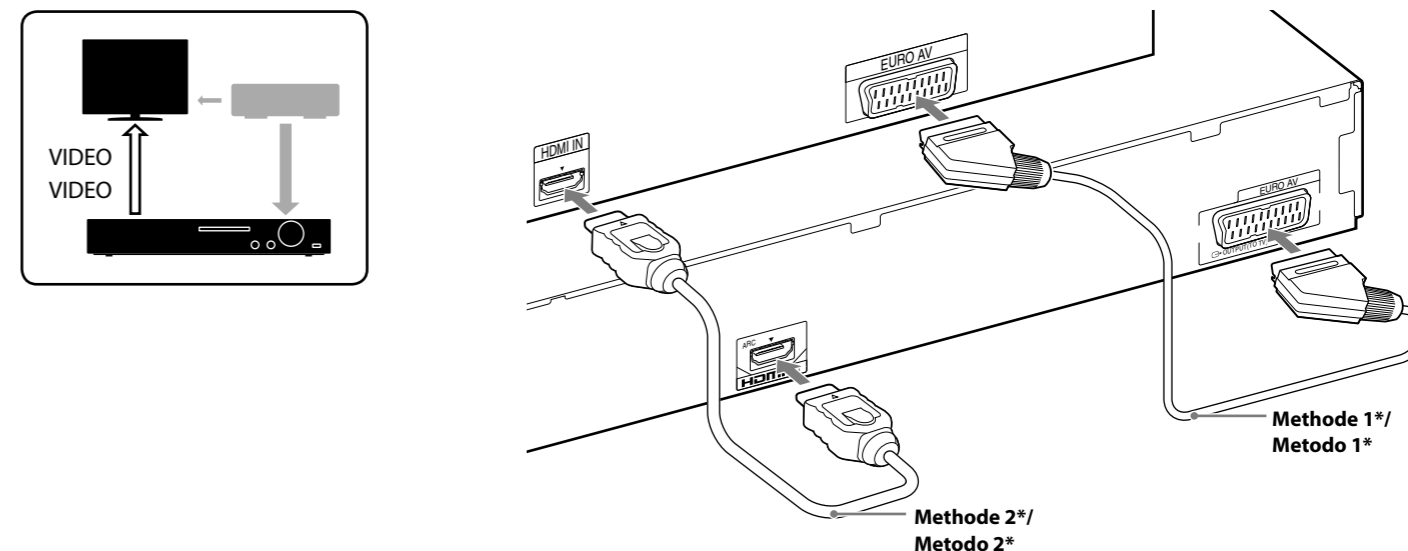

*Niet bijgeleverd/*Non in dotazione

Audioverbinding van uw set-top box/Collegamento dell'audio dal decoder

Als u geen set-top box gebruikt, raadpleegt u "Een tv/set-top box aansluiten" in de gebruiksaanwijzing.
Se non si utilizza un decoder, fare riferimento alla sezione "Collegamento del televisore/decoder" nelle Istruzioni per l'uso.

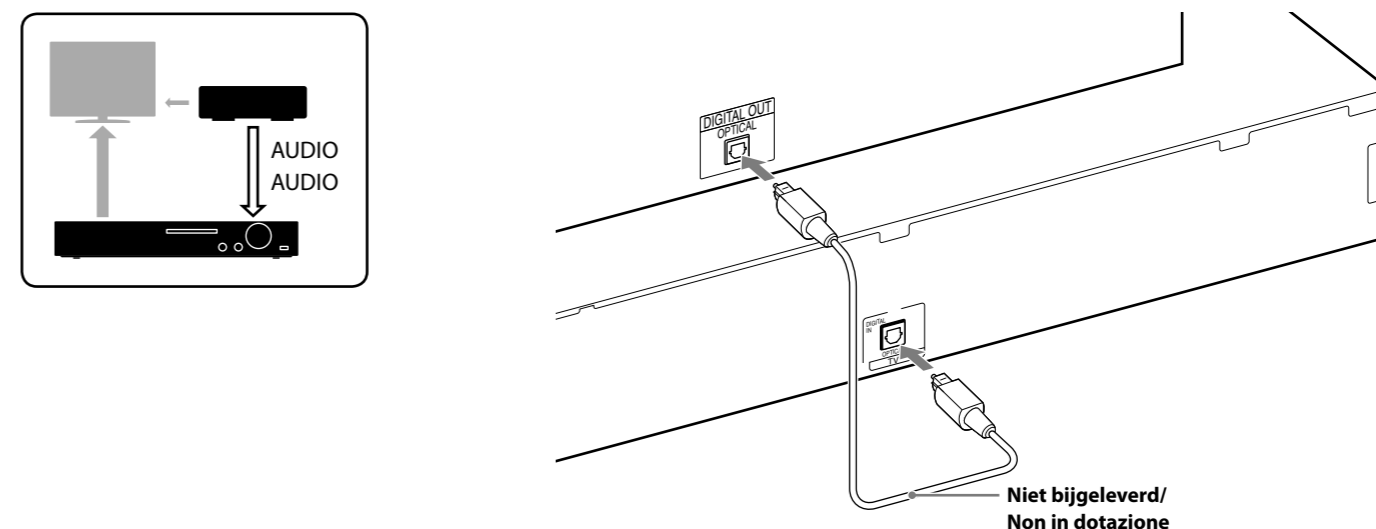

3 De snelle instelling uitvoeren/Esecuzione della configurazione rapida

Opmerking

Plaats geen disc voor u de snelle instelling hebt uitgevoerd.

Nota

Non inserire alcun disco prima di eseguire la configurazione rapida.

1 Sluit het netsnoer aan.

De vorm van het stopcontact verschilt naargelang de regio.

Collegamento del cavo di alimentazione CA.

La forma della presa a muro varia a seconda della zona geografica.

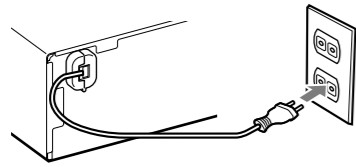

2 Schakel het hoofdapparaat en de tv in.

Accendere l'unità principale e il televisore.

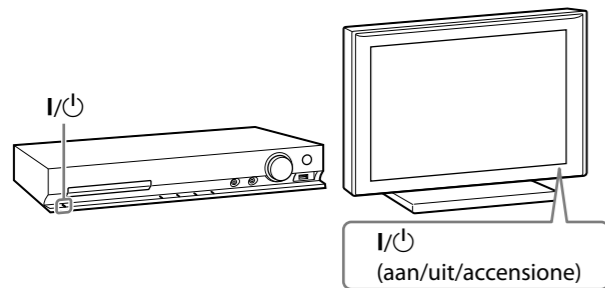

3 Wijzig de invoer van uw tv zodat "SONY Home Theatre System" wordt weergegeven.

Impostare il selettore di ingresso del televisore per visualizzare "SONY Home Theatre System".

4 Stel de volgende items in met $\leftarrow/\uparrow/\downarrow/\rightarrow$ en \oplus.

Impostare ciascuna delle seguenti voci, mediante $\leftarrow/\uparrow/\downarrow/\rightarrow$ e \oplus.

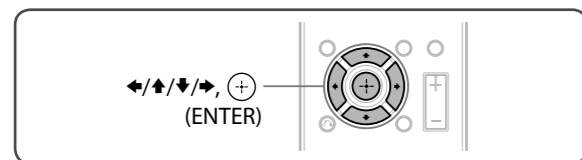

Opmerking

De weergegeven items verschillen naargelang de regio.

Nota

Le voci visualizzate dipendono dalla zona geografica.

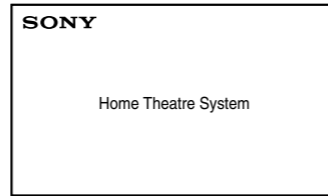

Selecteer een schermtaal.

Selezionare una lingua a schermo.

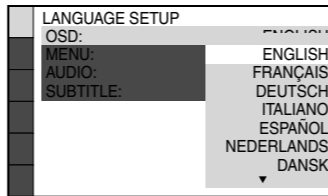

Selecteer de breedte-/hoogteverhouding van de aangesloten tv.

Selezionare il rapporto di formato del televisore collegato.

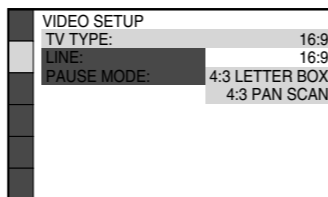

Selecteer de uitvoermethode voor videosignalen.

Selezionare il metodo di uscita dei segnali video.

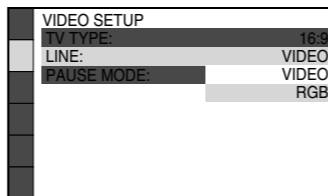

Selecteer [AAN] wanneer u het hoofdapparaat en de tv aansluit met een HDMI-kabel.

Selezionare [ON] quando si collegano l'unità principale e il televisore con un cavo HDMI.

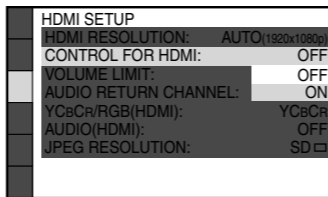

Selecteer de luidsprekeropstelling.

Selezionare la disposizione dei diffusori.

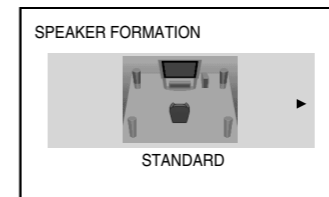

Sluit de kalibratiemicrofoon aan en plaats deze op de luisterpositie.

Collegare il microfono di calibrazione e impostarlo sulla posizione di ascolto.

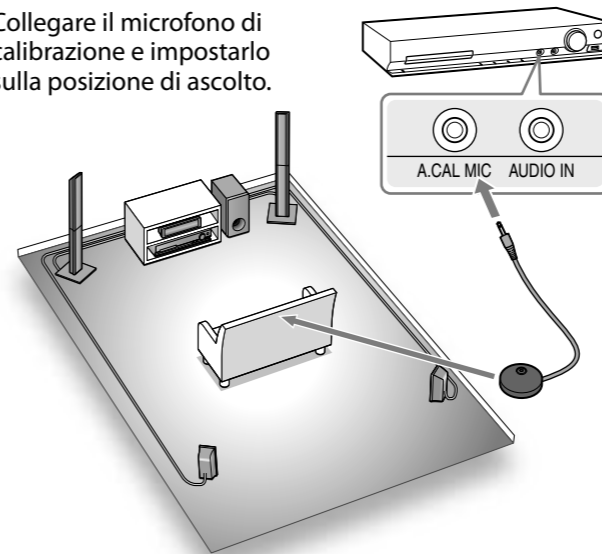

Selecteer [JA] om [AUTOKALIBRATIE] uit te voeren.

Selezionare [S] per eseguire [CALIBRAZIONE AUTO].

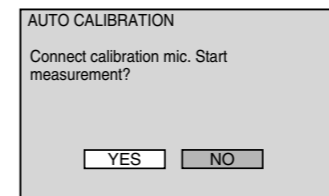

Selecteer [JA] om de meetresultaten op te slaan.

Selezionare [S] per salvare i risultati della misurazione.

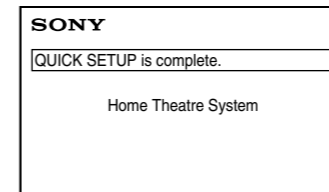
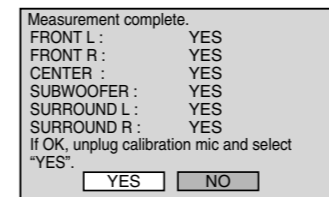

Luisteren naar het geluid van de tv via alle luidsprekers/Ascolto dell'audio del televisore da tutti i diffusori

1 Druk op TV. Premere TV.

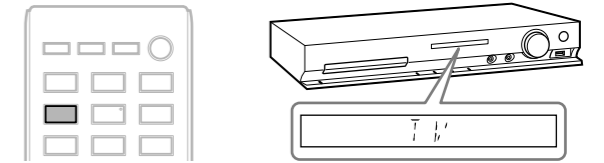

2 Druk op SYSTEM MENU. Premere SYSTEM MENU.

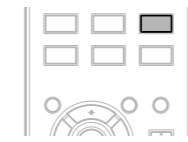

3 Druk op \uparrow/\downarrow om "SUR.SETTING" weer te geven en druk daarna op \oplus.

Premere \uparrow/\downarrow per visualizzare "SUR.SETTING", quindi premere \oplus.

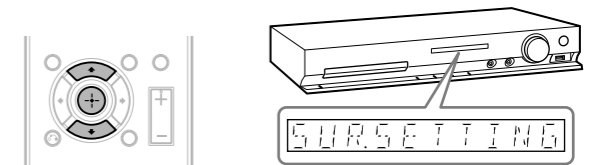

4 Druk op \uparrow/\downarrow om "PRO LOGIC" weer te geven en druk daarna op \oplus.

Premere \uparrow/\downarrow per visualizzare "PRO LOGIC", quindi premere \oplus.

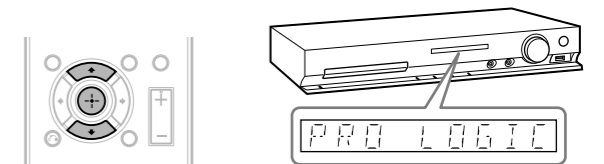

5 Druk op SYSTEM MENU om het menu te verlaten. Premere SYSTEM MENU per uscire dal menu.

